

Article number: 20127425

Description: E+G Ball knob DIN 319-ST-25-M6-C

Measures

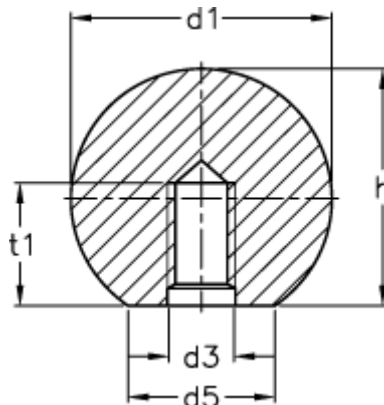

d1	= 25
d3	= M6
d5	= 15
h	= 22.5
t1 min.	= 11.0